

SMD Indust COG HT200C, Ceramic, 47 pF, 5%, 100 VDC, COG, SMD, MLCC, High Temperature, Ultra-Stable, Low Loss, 0603

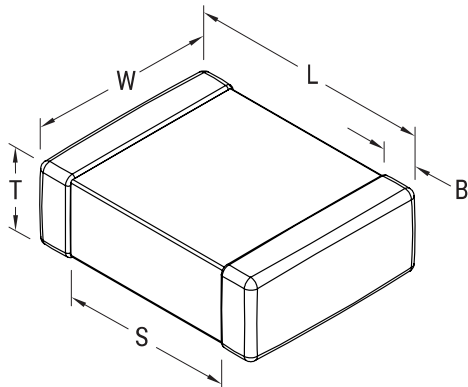

Dimensions

L	1.6mm +/-0.15mm
W	0.8mm +/-0.15mm
T	0.8mm +/-0.07mm
S	0.7mm MIN
B	0.35mm +/-0.15mm

Packaging Specifications

Packaging:	Bulk, Bag
Packaging Quantity:	1

General Information

Series:	SMD Indust COG HT200C
Style:	SMD Chip
Description:	SMD, MLCC, High Temperature, Ultra-Stable, Low Loss
Features:	High Temp, Ultra-Stable, Low Loss
RoHS:	Yes
Termination:	Gold
Marking:	No
AEC-Q200:	No
Miscellaneous:	Gold (Au) 100 micro inches min.
Chip Size:	0603
Shelf Life:	78 Weeks
MSL:	1

Specifications

Capacitance:	47 pF, 1MHz 1.0Vrms
Capacitance Tolerance:	5%
Voltage DC:	100 VDC
Dielectric Withstanding Voltage:	250 VDC
Temperature Range:	-55/+200°C
Temperature Coefficient:	COG
Capacitance Change with Reference to +25°C and 0 VDC Applied (TCC):	30 ppm/C, 1MHz 1.0Vrms
Dissipation Factor:	0.10% 1MHz 1.0Vrms
Aging Rate:	0% Loss/Decade Hour
Insulation Resistance:	100 GOhms

Statements of suitability for certain applications are based on our knowledge of typical operating conditions for such applications, but are not intended to constitute - and we specifically disclaim - any warranty concerning suitability for a specific customer application or use. This Information is intended for use only by customers who have the requisite experience and capability to determine the correct products for their application. Any technical advice inferred from this Information or otherwise provided by us with reference to the use of our products is given gratis, and we assume no obligation or liability for the advice given or results obtained.

单击下面可查看定价，库存，交付和生命周期等信息

[>>KEMET\(基美\)](#)